

NOTE:
 1. SUCTION PIPES IN WETWELL AND MANHOLE SHOULD BE 18" FROM BOTTOM



BAY COUNTY UTILITIES STANDARD DETAILS

EMERGENCY BYPASS PUMP PIPE LAYOUT

DATE:
 SCALE: NTS

FIGURE:

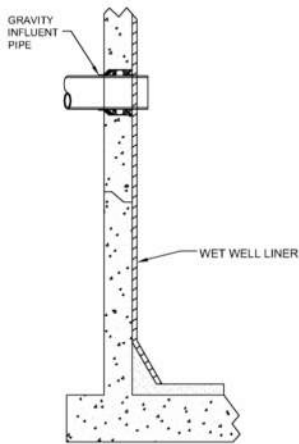

SECTION "B-B"

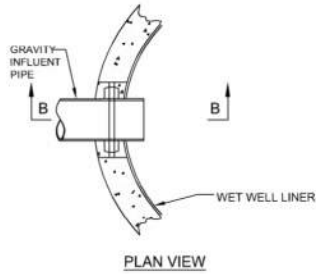

PLAN VIEW

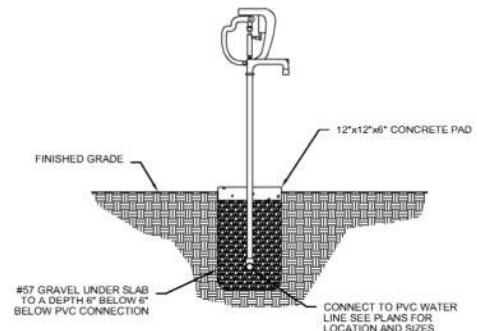

FREEZE PROOF YARD HYDRANT

NTS

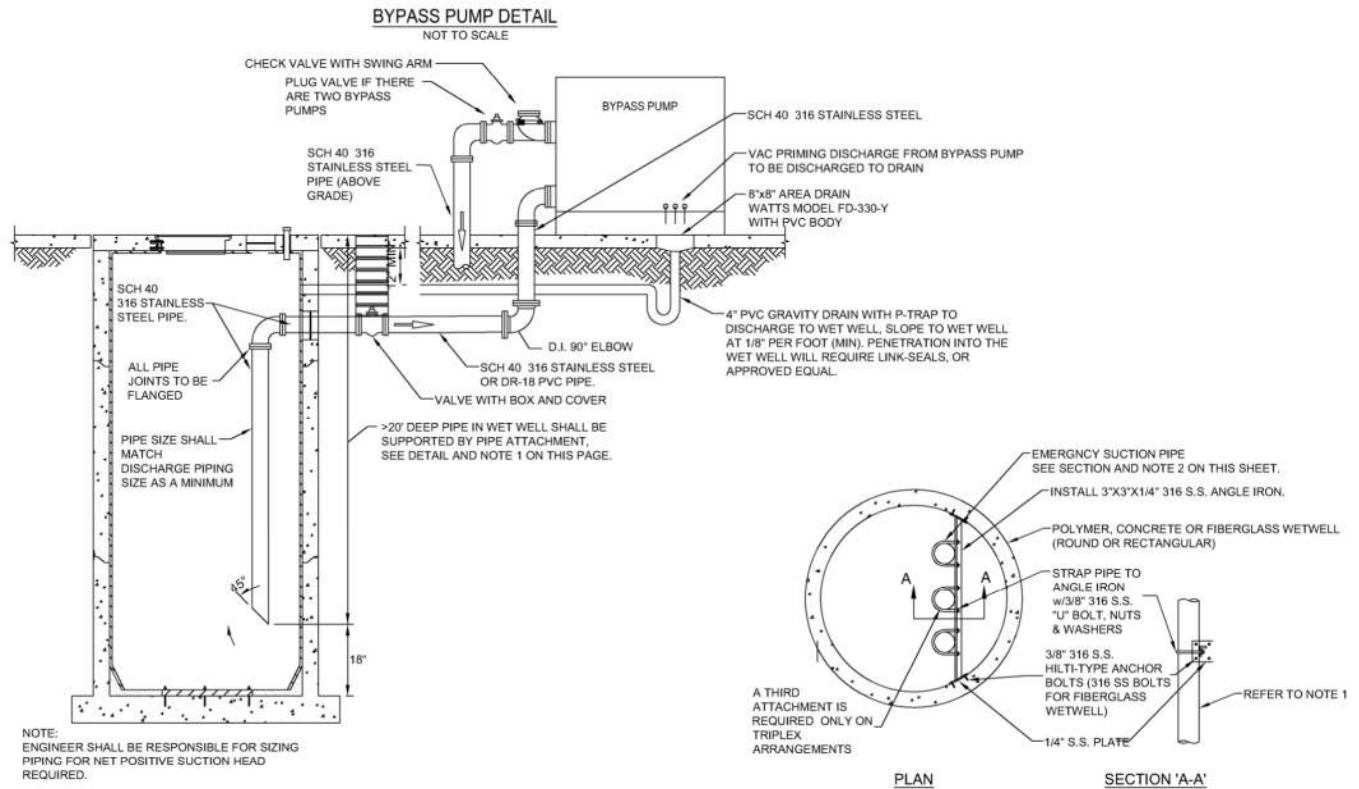

NOTE:
ENGINEER SHALL BE RESPONSIBLE FOR SIZING PIPING FOR NET POSITIVE SUCTION HEAD REQUIRED.

THE ABOVE PIPING IS SHOWN FOR CLARITY. SEE PLAN VIEW FOR PIPE ORIENTATION.

WETWELL CONNECTION TO BYPASS PUMP DETAIL

NOT TO SCALE

PLAN

SECTION 'A-A'

PIPE ATTACHMENT TO WALL DETAIL

REQUIRED FOR ALL PUMPING STATIONS WITH WETWELL 20' DEEP AND GREATER (INSTALLED PRIOR TO SPECIALTY LINER)

NOT TO SCALE

- NOTE:
1. STRAP EACH PIPE WITHIN 12' OF BOTTOM, THEN EVERY 10' C/C.
 2. SUCTION PIPE SHOWN FOR CLARITY, LOCATION WILL BE SITE SPECIFIC



BAY COUNTY
UTILITIES
STANDARD
DETAILS

EMERGENCY BYPASS PUMP PIPE LAYOUT

DATE:
SCALE: NTS

FIGURE:

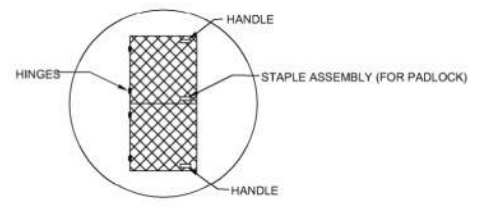
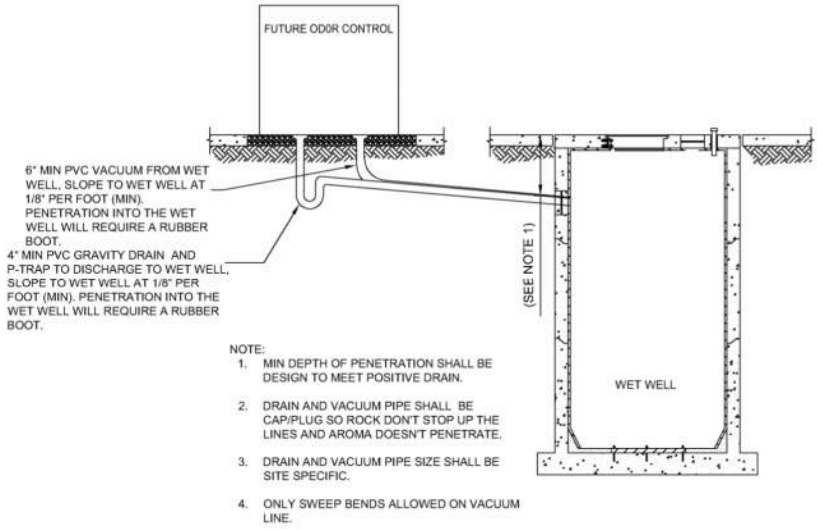

WET WELL HATCH DETAIL
NOT TO SCALE

ODOR CONTROL DRAIN AND VACUUM CONNECTION TO WET WELL DETAIL
NOT TO SCALE

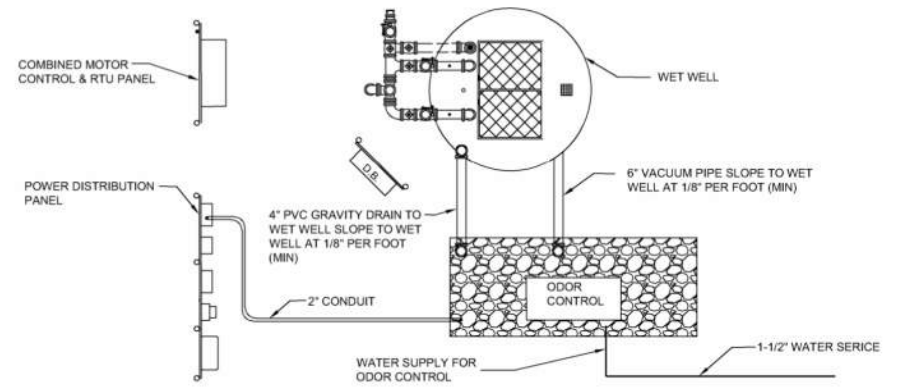

ODOR CONTROL STUB OUT DETAIL
NOT TO SCALE

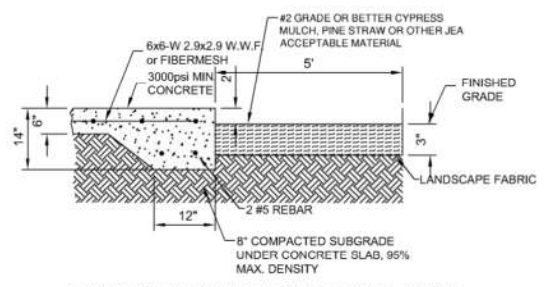

CONCRETE SLAB AND GROUND COVER DETAIL
NOT TO SCALE



BAY COUNTY
UTILITIES
STANDARD
DETAILS

EMERGENCY
BYPASS PUMP
PIPE LAYOUT

DATE:
SCALE: NTS

FIGURE: